

31.04515 MINE TRACK LIGHTING

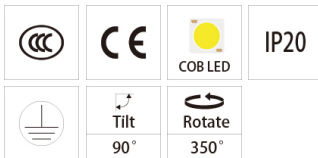
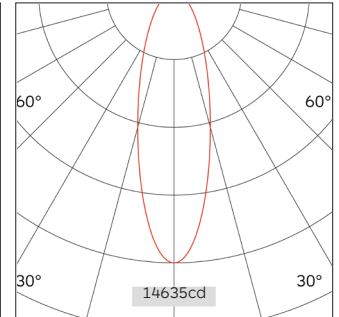
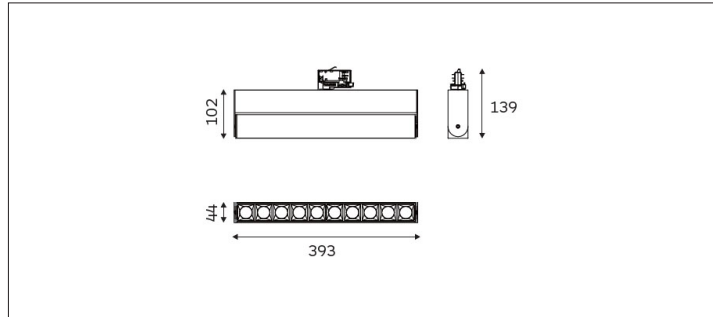
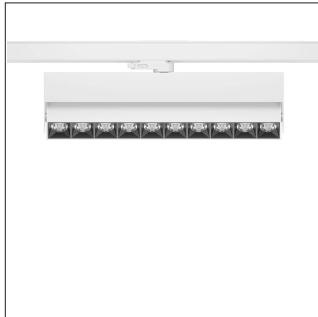

Light Distribution	MINE TRACK LIGHTING
Colour Temperature	2700/3000/3500/4000K
Colour Rendition Index	CRI 90
Optics	Lens
Beam Angle	23D/49D
Track Phases	1 Circuit/ 3 Circuit
Connected Load	40W
Luminous Flux Of The Luminaire	3485 lm
Luminaire Efficacy	87.13lm/W
Colour Deviation	SDCM <5
Light Source	LED
LED Type	SMD
Dimming Method	Triac/1-10V/ Dali
Cover Material	Aluminum
Body Material	Aluminum
IP Rating	IP20
Housing Colour	Sandy White/ Sandy Black
Weight	0.8Kg
Technical Region	220-240V 50/60Hz

Light Beam Talbe		
h(m)	E(lx)	D(m)
		23°
1.0	14635.59	0.41
2.0	3658.90	0.82
3.0	1626.18	1.23
4.0	914.72	1.64
5.0	585.42	2.04

High lumen track lights use LED technology, which is more energy efficient than traditional lighting products. Classic style rail fixtures often incorporate design elements of traditional fixtures for a classic and elegant look.