

32.10111 High Lumen Pro Track Lighting

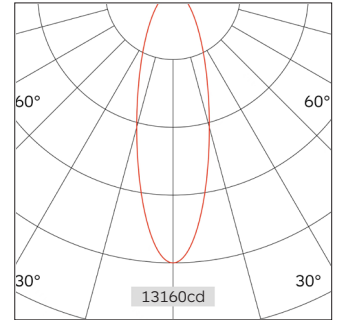
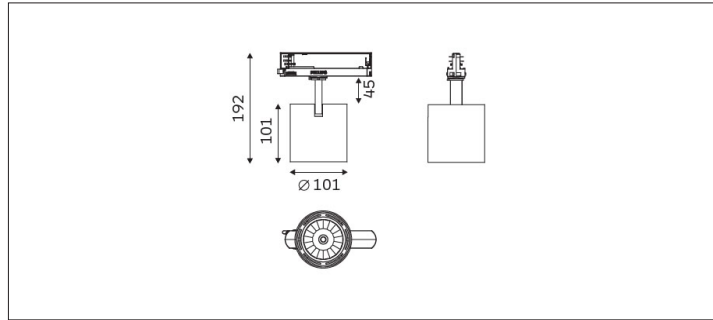

Light Distribution	High lumen Pro Track Lighting
Colour Temperature	2700/3000/3500/4000K
Colour Rendition Index	CRI 90
Optics	Reflector
Beam Angle	18D/25D/47D/64D
Track Phases	1 Circuit/ 3 Circuit
Connected Load	32W
Luminous Flux Of The Luminaire	4251 lm
Luminaire Efficacy	132.8lm/W
Colour Deviation	SDCM<5
Light Source	LED
LED Type	COB
Dimming Method	Triac/0-10V/ Dali
Cover Material	Aluminum
Body Material	Aluminum
IP Rating	IP20
Housing Colour	Sandy White/ Sandy Black
Weight	0.8Kg
Technical Region	220-240V 50/60Hz

Light Beam Talbe

h(m)	E(lx)	D(m)
		25°
1.0	13160.81	0.44
2.0	3290.20	0.88
3.0	1462.31	1.32
4.0	822.55	1.76
5.0	526.43	2.20

High lumen track lights use LED technology, which is more energy efficient than traditional lighting products. Classic style rail fixtures often incorporate design elements of traditional fixtures for a classic and elegant look.