

# 51.03023 Mini Recessed Downlight

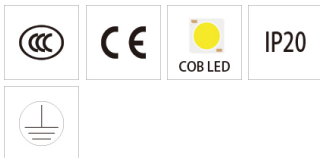
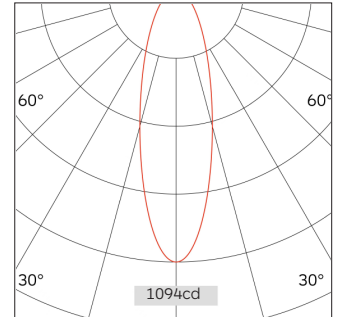
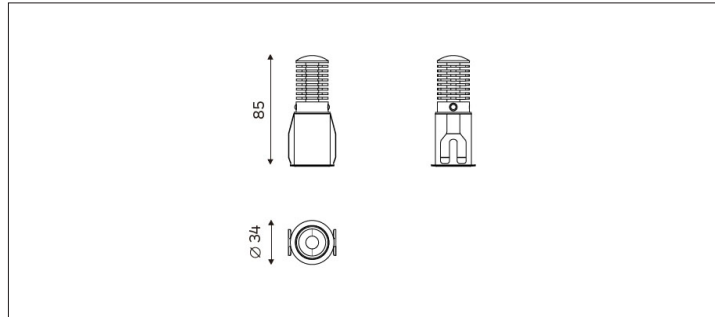

Light Distribution	Mini Recessed Downlight
Colour Temperature	2700/3000/3500/4000K
Colour Rendition Index	CRI 90
Optics	Lens
Beam Angle	19D/24D/35D/53D
Cut Out	30mm
Connected Load	3.6W
Luminous Flux Of The Luminaire	232lm
Luminaire Efficacy	64.4lm/W
Colour Deviation	SDCM < 5
Light Source	LED
LED Type	COB
Dimming Method	Triac/0-10V/ Dali
Cover Material	Aluminum
Body Material	Aluminum
IP Rating	IP20
Housing Colour	Sandy White/ Sandy Black
Weight	0.35Kg
Technical Region	220-240V 50/60Hz

Light Beam Talbe

h(m)	E(lx)	D(m)
		24°
1.0	1094.23	0.43
2.0	273.56	0.86
3.0	121.58	1.29
4.0	68.39	1.72
5.0	43.77	2.15

High-end residential, retail projects, hotels, museums and galleries. Can be a variety of combinations, put together different shapes, to achieve the effect of only see the light does not see the light.