

31.04513 MINE TRACK LIGHTING

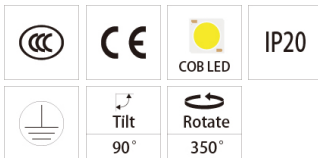
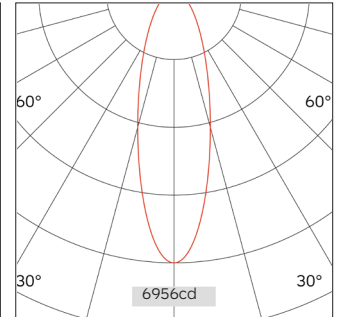
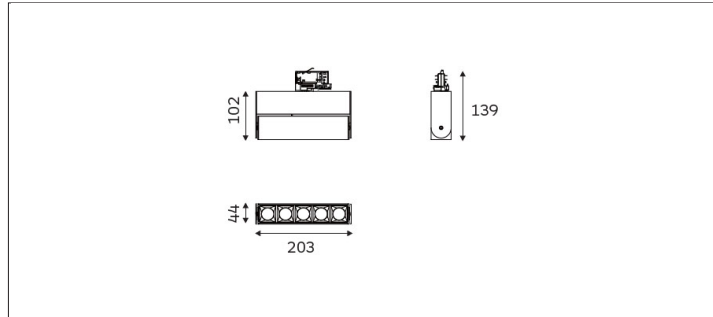
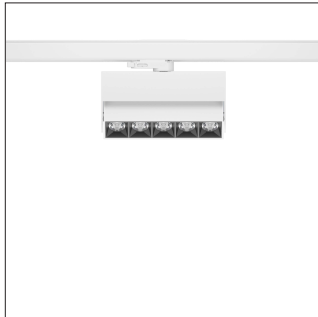

Light Distribution	MINE TRACK LIGHTING
Colour Temperature	2700/3000/3500/4000K
Colour Rendition Index	CRI 90
Optics	Lens
Beam Angle	23D/50D
Track Phases	1 Circuit/ 3 Circuit
Connected Load	20W
Luminous Flux Of The Luminaire	1824 lm
Luminaire Efficacy	91.2lm/W
Colour Deviation	SDCM <5
Light Source	LED
LED Type	SMD
Dimming Method	Triac/1-10V/ Dali
Cover Material	Aluminum
Body Material	Aluminum
IP Rating	IP20
Housing Colour	Sandy White/ Sandy Black
Weight	0.6Kg
Technical Region	220-240V 50/60Hz

Light Beam Talbe		
h(m)	E(lx)	D(m)
		23°
1.0	6956.27	0.41
2.0	1739.07	0.83
3.0	772.92	1.24
4.0	434.77	1.66
5.0	278.25	2.07

High lumen track lights use LED technology, which is more energy efficient than traditional lighting products. Classic style rail fixtures often incorporate design elements of traditional fixtures for a classic and elegant look.