

31.04512 Mine Track Lighting

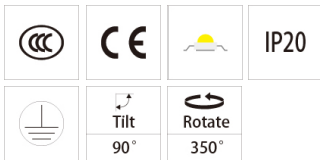
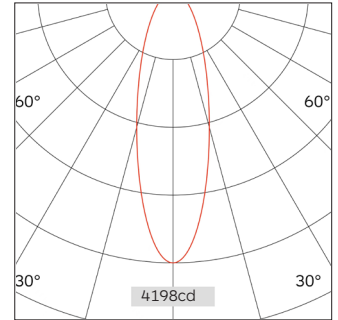
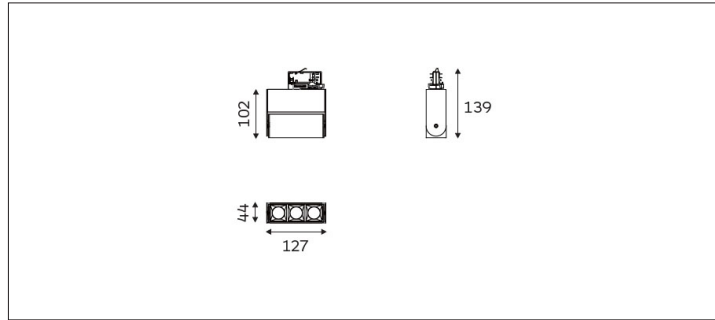
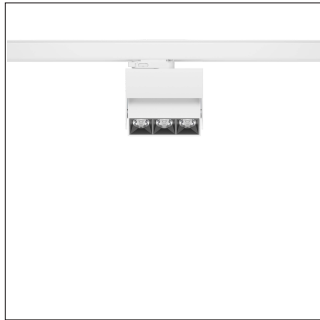

Light Distribution	Mine Track Lighting
Colour Temperature	2700/3000/3500/4000K
Colour Rendition Index	CRI 90
Optics	Lens
Beam Angle	23D/50D
Track Phases	1 Circuit/ 3 Circuit
Connected Load	12W
Luminous Flux Of The Luminaire	1049 lm
Luminaire Efficacy	87.42lm/W
Colour Deviation	SDCM<5
Light Source	LED
LED Type	SMD
Dimming Method	Triac/0-10V/ Dali
Cover Material	Aluminum
Body Material	Aluminum
IP Rating	IP20
Housing Colour	Sandy White/ Sandy Black
Weight	0.4Kg
Technical Region	220-240V 50/60Hz

Light Beam Talbe		
h(m)	E(lx)	D(m)
		23°
1.0	4198.69	0.41
2.0	1049.67	0.83
3.0	466.52	1.24
4.0	262.42	1.65
5.0	167.95	2.06

A modern design consisting for the purpose to meet the highest requirements of the latest advanced lighting technology. Application areas: retail, museums, hospitality, residential, offices and lobbies.