

56.03511 MINI Recessed Downlight-Adjust

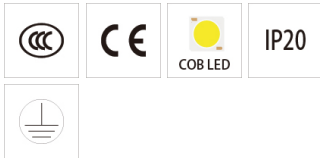
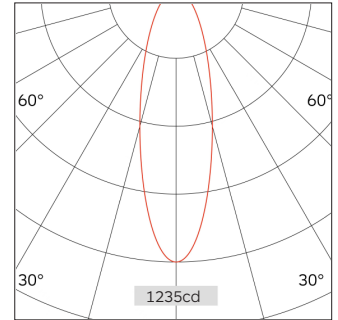
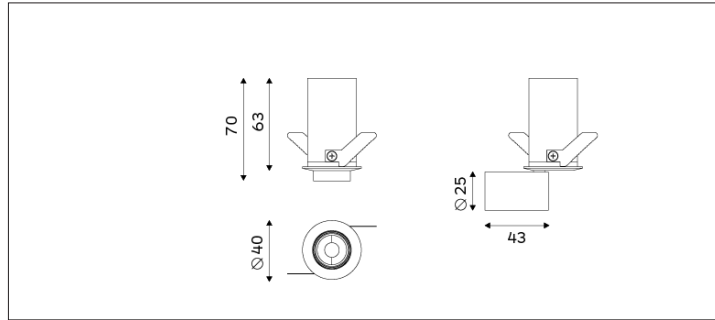

Light Distribution	MINI Recessed Downlight
Colour Temperature	2700/3000/3500/4000K
Colour Rendition Index	CRI 90
Optics	LENS
Beam Angle	17D/26D/31D/53D
Cut Out	35mm
Connected Load	3.8W
Luminous Flux Of The Luminaire	200lm
Luminaire Efficacy	52lm/W
Colour Deviation	SDCM <5
Light Source	LED
LED Type	COB
Dimming Method	Triac/1-10V/ Dali
Cover Material	Aluminum
Body Material	Aluminum
IP Rating	IP20
Housing Colour	Sandy White/ Sandy Black
Weight	0.2Kg
Technical Region	220-240V 50/60Hz

H(M)	E(lx)	D(M)
		26°
1.0	1235	0.46
2.0	308	0.93
3.0	137	1.39
4.0	77	1.86
5.0	49	2.32

Application areas: High end residential and retail projects, hotels, museums and galleries.