

# 56.04519 FOS Recessed Downlight

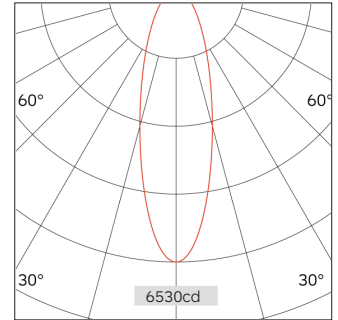
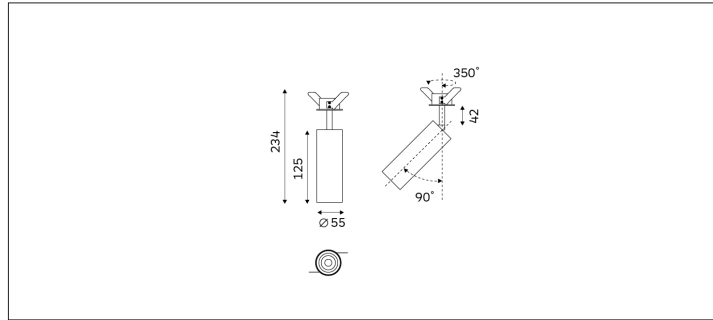

Light Distribution	FOS Recessed Downlight
Colour Temperature	2700/3000/3500/4000K
Colour Rendition Index	CRI 90
Optics	LENS
Beam Angle	20D/32D/41D/49D
Cut Out	45mm
Connected Load	16W
Luminous Flux Of The Luminaire	1871lm
Luminaire Efficacy	117lm/W
Colour Deviation	SDCM <5
Light Source	LED
LED Type	COB
Dimming Method	Triac/1-10V/ Dali
Cover Material	Aluminum
Body Material	Aluminum
IP Rating	IP20
Housing Colour	Sandy White/ Sandy Black
Weight	0.6Kg
Technical Region	220-240V 50/60Hz

H(M)	E(lx)	D(M)
		32°
1.0	6529.93	0.57
2.0	1632.48	1.14
3.0	725.55	1.71
4.0	408.12	2.28
5.0	261.20	2.85

Application areas: retail, museums, hospitality, residential, offices and lobbies.