

32.04516 EMMA Track Lighting-Intrack

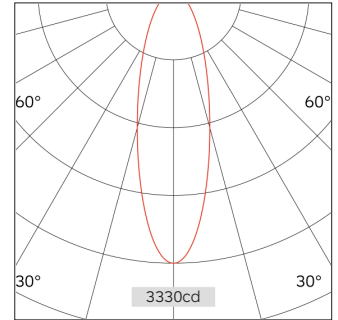
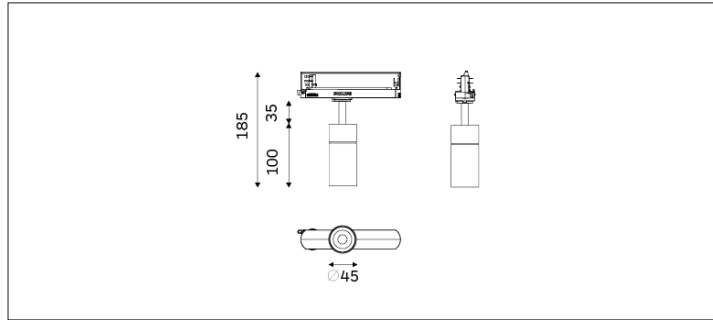

Light Distribution	Track Lighting-Intrack
Colour Temperature	2700/3000/3500/4000K
Colour Rendition Index	CRI 90
Optics	LENS
Beam Angle	16D/29D/44D/56D
Track Phases	1 Circuit/ 3 Circuit
Connected Load	11W
Luminous Flux Of The Luminaire	935lm
Luminaire Efficacy	87lm/W
Colour Deviation	SDCM <5
Light Source	LED
LED Type	COB
Dimming Method	Triac/1-10V/ Dali
Cover Material	Aluminum
Body Material	Aluminum
IP Rating	IP20
Housing Colour	Sandy White/ Sandy Black
Weight	0.40Kg
Technical Region	220-240V 50/60Hz

Light Beam Talbe		
h(m)	E(lx)	D(m)
		29°
1.0	3330	0.53
2.0	1480	0.80
3.0	832	1.06
4.0	533	1.33
5.0	370	1.60

Application areas: retail, museums, hospitality, residential, offices and lobbies.